





Residential Photovoltaic Energy Storage System,  
the state-of-art intelligent power solution

# STORION SERIES SMILE5



## ✓ Key Features

- S**elf sufficient
- M**odular battery
- I**ntelligent control
- L**ong lifespan
- E**ssential load protected
- 5** kW system
-  **Fast response**
-  **Light load threshold**
-  **UPS enabled**
-  **IP65 outdoor rated**
-  **24/7 Monitoring**



**Real-time Monitoring**  
All systems can be monitored  
by **Web and IOS/Android APP.**

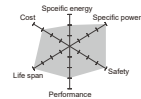

**Safest Chemistry**  
AlphaESS adapts Li-phosphate for its  
excellent safety and long life span.



product  
design award 2018



reddot design award 2018

### About AlphaESS

As one of the earliest pioneers in energy storage market with lithium iron technology, AlphaESS has a vision to pave the path for everyone in the world to enjoy clean energy one day.

We are a multinational company that currently has more than 10'000 residential and commercial systems running in 30 countries globally and our products are accredited by IEC, TÜV, CEC and many other international standards.

All AlphaESS energy systems are integrated with smart energy management solutions. AlphaESS is committed to revolutionize the future energy network through our patented German technologies.



Official Website



Scan to download  
APP (IOS/Android)



Twitter



FaceBook

## System Configuration

<b>Model</b>	Storion-SMILE5
<b>Nominal Output Power</b>	5000 W / 4600 W (DE)
<b>Max. Input PV Power</b>	6600 W
<b>Capacity Range</b>	5.7 kWh ~ 34.4 kWh (90% DoD)
<b>Battery Chemistry</b>	LFP (LiFePO <sub>4</sub> )
<b>IP Protection</b>	IP65
<b>Warranty</b>	5 year product warranty / 10 year performance warranty

## Inverter Technical Specification

<b>Model</b>	SMILE5-INV		
<b>Max. Input PV Current</b>	2 x 12 A	<b>Backup</b>	UPS
<b>Max. Input PV Voltage</b>	580 Vdc	<b>Display</b>	LCD
<b>MPPT Number</b>	2	<b>Communication</b>	Ethernet
<b>MPPT Voltage Range</b>	125 V ~ 550 V	<b>Operating Temperature Range</b>	-10°C ~ 50°C*
<b>Max. Charge Power</b>	5 kW	<b>Humidity</b>	15% ~ 85% (No Condensing)
<b>Max. Discharge Power</b>	5 kW	<b>Dimensions (W x D x H)</b>	600 mm x 250 mm x 600 mm
<b>Phase</b>	Single-Phase	<b>Weight</b>	60 kg
<b>Output Voltage</b>	180 ~ 270 Vac	<b>Grid Regulation</b>	VDE-AR-N 4105, VDE 0126-1-1, AS 4777.2/3, CEI 0-21: 2014, G59/3
<b>Grid Frequency</b>	50/60 Hz	<b>Safety</b>	IEC 62109-1&-2

## Battery Technical Specification

<b>Module Model</b>	SMILE5-BAT
<b>Module Capacity</b>	5.7 kWh
<b>Module Weight</b>	65 kg
<b>Module Dimension</b>	600 mm x 250 mm x 600 mm
<b>Max. Modules in Parallel</b>	6
<b>Max. Charge/Discharge Current</b>	0.5 C
<b>Cycle Life</b>	≥ 6000

\* When the temperature is below 0°C or above 40°C, the performance will be limited.

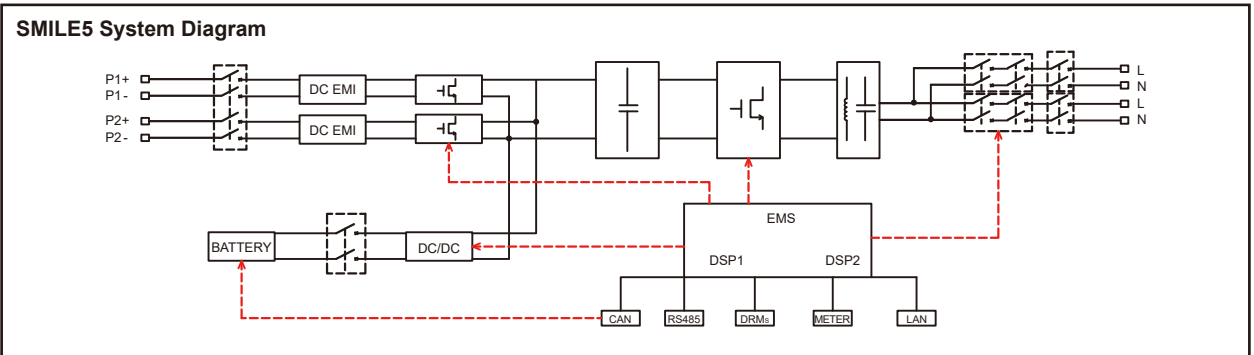

Headquarter: Alpha ESS Co., Ltd.

+86 (0) 513 806 068 91

info@alpha-ess.com

www.alpha-ess.com

Jiuhua Road 888, Nantong High-Tech Industrial Development Zone, Nantong City, 226300

Germany: Alpha ESS Europe GmbH

+49 (0) 6103 / 459 160-1

europe@alpha-ess.de

www.alpha-ess.de

Paul-Ehrlich-Straße 1a, 63225 Langen, Hessen

Australia: Alpha ESS Australia PTY. Ltd.

+61 (0) 402 500 520 (Sales)

+61 1300 968 933 (Technical Support)

australia@alpha-ess.com

www.alpha-ess.com.au

Suite 2, Level 1, 530 Botany Road, Alexandria, NSW, 2015

Italy: Alpha ESS Italy S.r.l.

+39 (0) 599 239 50

info@alpha-ess.it

www.alpha-ess.it

Via Loda, 17-41013 Castelfranco Emilia(MO)